

KH205

Overdrive-Protected Wideband Op Amp

Features

- -3dB bandwidth of 170MHz
- 0.1% settling in 22ns
- Complete overdrive protection
- Low power: 570mW (190mW at $\pm 5V$)
- $3M\Omega$ input resistance
- Output may be current limited
- Direct replacement for CLC205

Applications

- Fast, precision A/D conversion
- Automatic test equipment
- Input/output amplifiers
- Photodiode, CCD preamps
- IF processors
- High-speed modems, radios
- Line drivers

General Description

The KH205 is a wideband overdrive-protected operational amplifier designed for applications needing both speed and low power operation. Utilizing a well-established current feedback architecture, the KH205 exhibits performance far beyond that of conventional voltage feedback op amps. For example, the KH205 has a bandwidth of 170MHz at a gain of +20 and settles to 0.1% in 22ns. Plus, the KH205 has a combination of important features not found in other high-speed op amps.

For example, the KH205 has been designed to consume little power – 570mW at $\pm 15V$ supplies. The result is lower power supply requirements and less system-level heat dissipation. In addition, the device can be operated on supply voltages as low as $\pm 5V$ for even lower power dissipation.

Complete overdrive protection has been designed into the part. This is critical for applications, such as ATE and instrumentation, which require protection from signal levels high enough to cause saturation of the amplifier. This feature allows the output of the op amp to be protected against short circuits using techniques developed for low-speed op amps. With this capability, even the fastest signal sources can feature effective short circuit protection.

The KH205 is constructed using thin film resistor/bipolar transistor technology, and is available in the following versions:

KH205AI	-25°C to +85°C	12-pin TO-8 can
KH205AK	-55°C to +125°C	12-pin TO-8 can, features burn-in & hermetic testing
KH205AM	-55°C to +125°C	12-pin TO-8 can, environmentally screened and electrically tested to MIL-STD-883
KH205HXC	-55°C to +125°C	SMD#: 5962-9083501HXC
KH205HXA	-55°C to +125°C	SMD#: 5962-9083501HXA

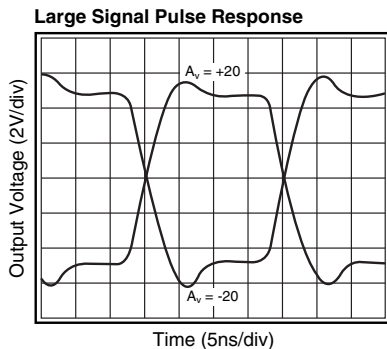

Bottom View

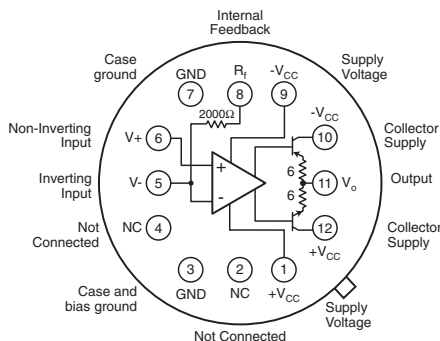

Pin 8 provides access to a 2000Ω feedback resistor which can be connected to the output or left open if an external feedback resistor is desired.

Typical Performance

Parameter	Gain Setting						Units
	+7	+20	+50	-1	-20	-50	
-3dB bandwidth	220	170	80	220	130	80	MHz
rise time	1.7	2.2	4.7	1.7	2.9	4.7	ns
slew rate	2.4	2.4	2.4	2.4	2.4	2.4	V/ns
settling time (to 0.1%)	22	22	20	21	20	19	ns

KH205 Electrical Characteristics (A_v = +20V, V_{CC} = ±15V, R_L = 200Ω, R_f = 2kΩ; unless specified)

PARAMETERS	CONDITIONS	TYP	MIN & MAX RATINGS			UNITS	SYM
Ambient Temperature	KH205AI	+25°C	-55°C	+25°C	+125°C		
Ambient Temperature	KH205AK/AM/HXC/HXA	+25°C	-55°C	+25°C	+125°C		
FREQUENCY DOMAIN RESPONSE							
+ -3dB bandwidth	V _o = <2V _{pp}	170	>140	>140	>125	MHz	SSBW
large-signal bandwidth	V _o = <10V _{pp}	100	>72	>80	>80	MHz	FPBW
gain flatness	V _o = <2V _{pp}						
+ peaking	0.1 to 35MHz	0	<0.3	<0.3	<0.5	dB	GFPL
+ peaking	>35MHz	0	<0.5	<0.5	<0.8	dB	GFPH
+ rolloff	at 70MHz	-	<0.8	<0.8	<0.8	dB	GFR
group delay	to 70MHz	3.0 ± .2	-	-	-	ns	GD
linear phase deviation	to 70MHz	0.8	<3.0	<2.0	<3.0	°	LPD
TIME DOMAIN RESPONSE							
rise and fall time	2V step	2.2	<2.6	<2.6	<3.0	ns	TRS
	10V step	4.8	<5.5	<5.5	<5.5	ns	TRL
settling time to 0.1%	10V step, note 2	22	<27	<27	<27	ns	TS
to 0.05%	10V step, note 2	24	<30	<30	<30	ns	TSP
overshoot	5V step	7	<14	<14	<14	%	OS
slew rate	20V _{pp} at 50MHz	2.4	>1.8	>2.0	>2.0	V/ns	SR
NOISE AND DISTORTION RESPONSE							
+ 2nd harmonic distortion	2V _{pp} , 20MHz	-57	<-50	<-50	<-50	dBc	HD2
+ 3rd harmonic distortion	2V _{pp} , 20MHz	-68	<-55	<-55	<-55	dBc	HD3
equivalent input noise							
voltage	>100kHz	2.1	<3.0	<3.0	<3.5	nV/√Hz	VN
inverting current	>100kHz	22	<30	<30	<35	pA/√Hz	ICN
non-inverting current	>100kHz	4.8	<6.5	<6.5	<7.5	pA/√Hz	NCN
noise floor	>100kHz	-157	<-154	<-154	<-153	dBm(1Hz)	SNF
integrated noise	1kHz to 150MHz	39	<55	<55	<61	μV	INV
noise floor	>5MHz	-157	<-154	<-154	<-153	dBm(1Hz)	SNF
integrated noise	5MHz to 150MHz	39	<55	<55	<61	μV	INV
STATIC, DC PERFORMANCE							
* input offset voltage		3.5	<8.0	<8.0	<11.0	mV	VIO
average temperature coefficient		11	<25	<25	<25	μV/°C	DVIO
* input bias current	non-inverting	3.0	<25	<15	<15	μA	IBN
average temperature coefficient		15	<100	<100	<100	nA/°C	DIBN
* input bias current	inverting	2.0	<22	<10	<25	μA	IBI
average temperature coefficient		20	<150	<150	<150	nA/°C	DIBI
* power supply rejection ratio		69	>55	>55	>55	dB	PSRR
common mode rejection ratio		60	>50	>50	>50	dB	CMRR
* supply current	no load	19	<20	<20	<22	mA	ICC
MISCELLANEOUS PERFORMANCE							
non-inverting input resistance	DC	3.0	>1.0	>1.0	>1.0	MΩ	RIN
non-inverting input capacitance	70MHz	5.0	<7.0	<7.0	<7.0	pF	CIN
output impedance	DC	-	<0.1	<0.1	<0.1	Ω	RO
output voltage range	no load	±12	>±11	>±11	>±11	V	VO
internal feedback resistor							
absolute tolerance		-	-	<0.2	-	%	RFA
temperature coefficient		-	-	-100 ±40	-	ppm/°C	RFTC
inverting input current self limit		2.2	<3.0	<3.0	<3.2	mA	ICL

Min/max ratings are based on product characterization and simulation. Individual parameters are tested as noted. Outgoing quality levels are determined from tested parameters.

Absolute Maximum Ratings

V _{CC}	±20V
I _o	±75mA
common mode input voltage	±(V _{CC} - 1)V
differential input voltage	±3V
thermal resistance	(see thermal model)
operating temperature	AI: -25°C to +85°C
	AK/AM/HXC/HXA: -55°C to +125°C
sample tested storage temperature	-65°C to +150°C
lead temperature (soldering 10s)	+300°C

Recommended Operating Conditions

V _{CC}	±5V to ±15V
I _o	±50mA
common mode input voltage	±(V _{CC} - 5)V
gain range	+7 to +50, -1 to -50

- note 1:** * AI/AK/AM/HXC/HXA 100% tested at +25°C
 † AK/AM/HXC/HXA 100% tested at +25°C and at -55°C and +125°C
- † AI sample tested at +25°C

note 2: Settling time specifications require the use of an external feedback resistor (2Ω)

KH205 Typical Performance Characteristics ($T_A = +25^\circ\text{C}$, $A_V = +20$, $V_{CC} = \pm 15\text{V}$, $R_L = 200\Omega$; unless specified)

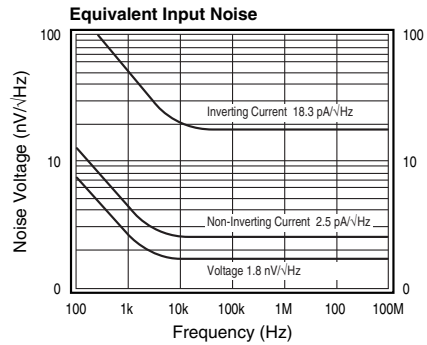
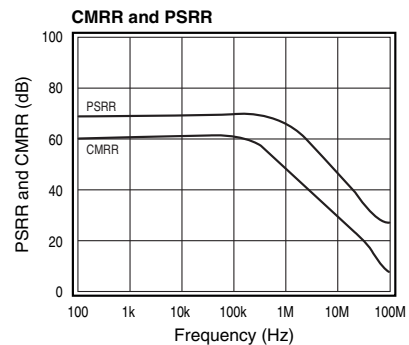
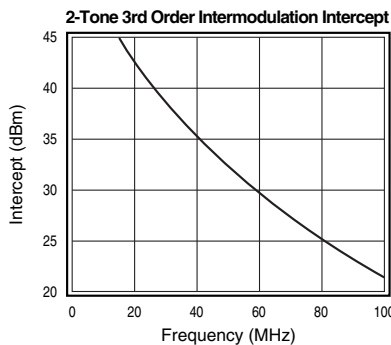
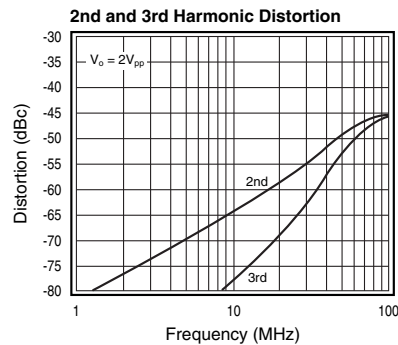
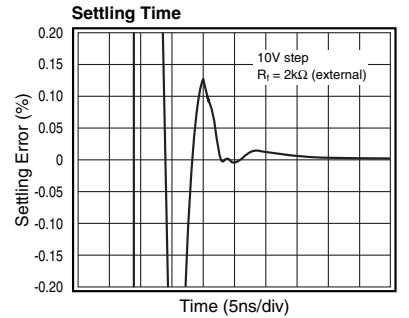
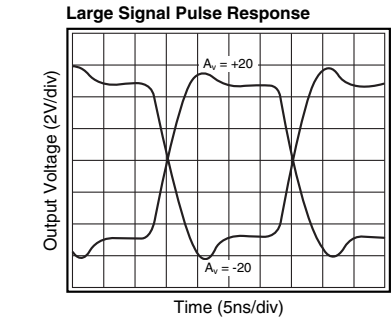
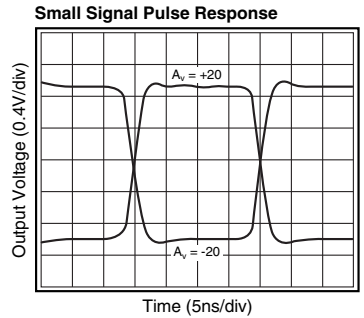
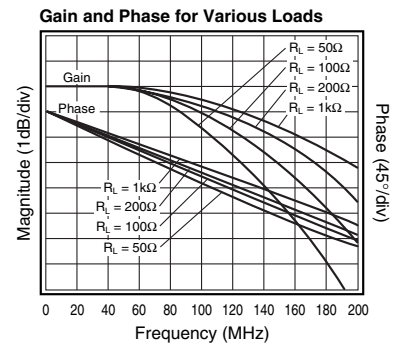
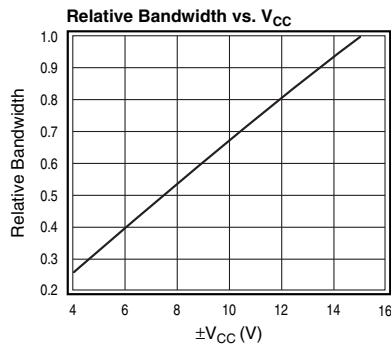
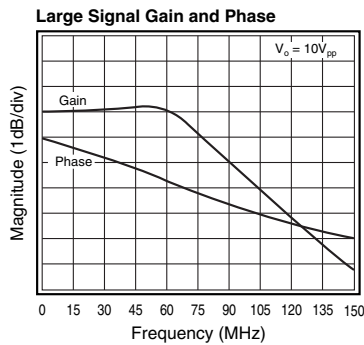
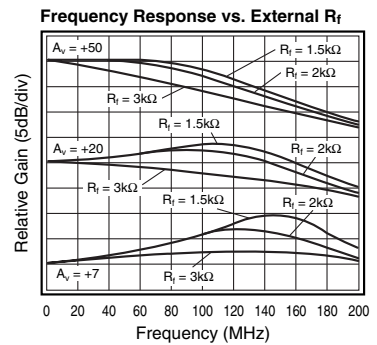
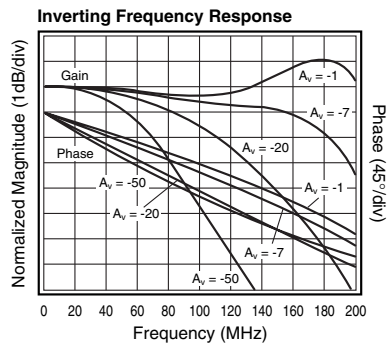
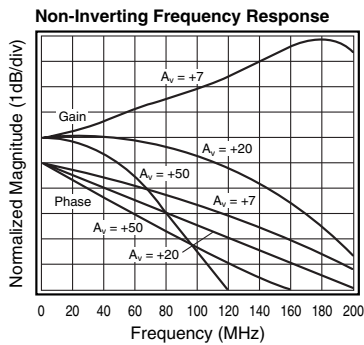

Thermal Model

$$P_{\text{circuit}} = [(+V_{CC}) - (-V_{CC})]^2 / 1.77\text{k}\Omega$$

$$P_{\text{xxx}} = [(\pm V_{CC}) - V_{\text{out}} - (I_{\text{col}})(R_{\text{col}} + 6)] (I_{\text{col}}) (\% \text{ duty cycle})$$

(For positive V_o and V_{CC} , this is the power in the npn output stage.)
 (For negative V_o and V_{CC} , this is the power in the pnp output stage.)

$I_{\text{col}} = V_{\text{out}}/R_{\text{load}}$ or 3mA, whichever is greater. (Include feedback R in R_{load} .)

R_{col} is a resistor (33 Ω recommended) between the xxx collector and $\pm V_{CC}$.

$T_{j(\text{pnp})} = P_{\text{pnp}}(200 + \theta_{\text{ca}}) + (P_{\text{cir}} + P_{\text{nnp}})\theta_{\text{ca}} + T_A$, similar for $T_{j(\text{nnp})}$.

$T_{j(\text{cir})} = P_{\text{cir}}(17.5 + \theta_{\text{ca}}) + (P_{\text{pnp}} + P_{\text{nnp}})\theta_{\text{ca}} + T_A$.

Current Feedback Amplifiers

Some of the key features of current feedback technology are:

- Independence of AC bandwidth and voltage gain
- Adjustable frequency response with feedback resistor
- High slew rate
- Fast settling

Current feedback operation can be described using a simple equation. The voltage gain for a non-inverting or inverting current feedback amplifier is approximated by Equation 1.

$$\frac{V_o}{V_{in}} = \frac{A_v}{1 + \frac{R_f}{Z(j\omega)}} \quad \text{Equation 1}$$

where:

- A_v is the closed loop DC voltage gain
- R_f is the feedback resistor
- $Z(j\omega)$ is the CLC205's open loop transimpedance gain
- $\frac{Z(j\omega)}{R_f}$ is the loop gain

The denominator of Equation 1 is approximately equal to 1 at low frequencies. Near the -3dB corner frequency, the interaction between R_f and $Z(j\omega)$ dominates the circuit performance. The value of the feedback resistor has a large affect on the circuits performance. Increasing R_f has the following affects:

- Decreases loop gain
- Decreases bandwidth
- Reduces gain peaking
- Lowers pulse response overshoot
- Affects frequency response phase linearity

Overdrive Protection

Unlike most other high-speed op amps, the KH205 is not damaged by saturation caused by overdriving input signals (where $V_{in} \times \text{gain} > \text{max. } V_o$). The KH205 self limits the current at the inverting input when the output is saturated (see the inverting input current self limit specification); this ensures that the amplifier will not be damaged due to excessive internal currents during overdrive. For protection against input signals which would exceed either the maximum differential or common mode input voltage, the diode clamp circuits below may be used.

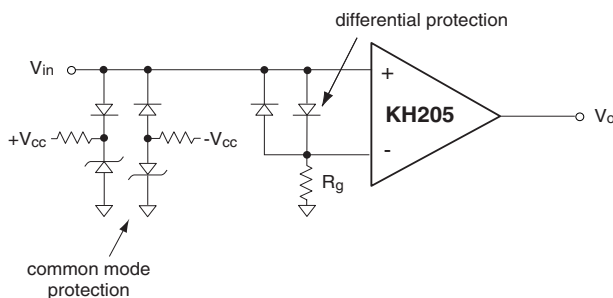

Figure 1: Diode Clamp Circuits for Common Mode and Differential Mode Protection

Short Circuit Protection

Damage caused by short circuits at the output may be prevented by limiting the output current to safe levels. The most simple current limit circuit calls for placing resistors between the output stage collector supplies and the output stage collectors (pins 12 and 10). The value of this resistor is determined by:

$$R_C = \frac{V_C}{I_l} - R_l$$

where I_l is the desired limit current and R_l is the minimum expected load resistance (0Ω for a short to ground). Bypass capacitors of $0.01\mu F$ on should be used on the collectors as in Figures 2 and 3.

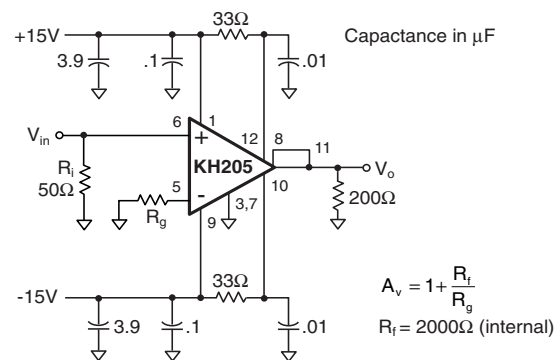

Figure 2: Recommended Non-Inverting Gain Circuit

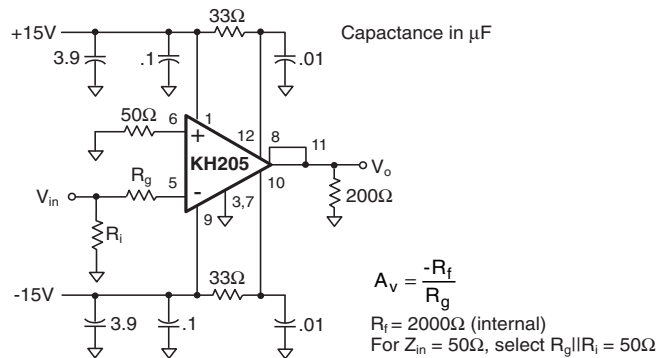

Figure 3: Recommended Inverting Gain Circuit

A more sophisticated current limit circuit which provides a limit current independent of R_l is shown in Figure 4 on page 5.

With the component values indicated, current limiting occurs at 50mA. For other values of current limit (I_l), select R_C to equal V_{be}/I_l . Where V_{be} is the base to emitter voltage drop of Q3 (or Q4) at a current of $[2V_{CC} - 1.4] / R_x$, where $R_x \leq [(2V_{CC} - 1.4) / I_l] B_{min}$.

Also, B_{min} is the minimum beta of Q1 (or Q2) at a current of I_l . Since the limit current depends on V_{be} , which is temperature dependent, the limit current is likewise temperature dependent.

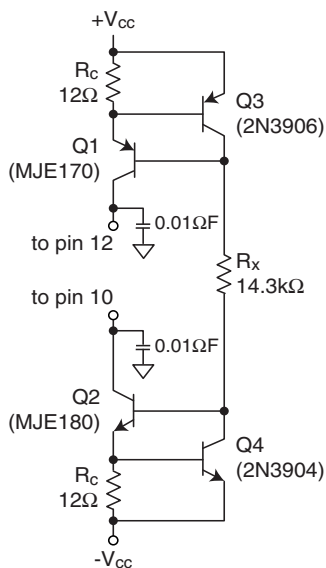

Figure 4: Active Current Limit Circuit (50mA)

Controlling Bandwidth and Passband Response

In most applications, a feedback resistor value of 2kΩ will provide optimum performance; nonetheless, some applications may require a resistor of some other value. The response versus R_f plot on the previous page shows how decreasing R_f will increase bandwidth (and frequency response peaking, which may lead to instability). Conversely, large values of feedback resistance tend to roll off the response.

The best settling time performance requires the use of an external feedback resistor (use of the internal resistor results in a 0.1% to 0.2% settling tail). The settling

performance may be improved slightly by adding a capacitance of 0.4pF in parallel with the feedback resistor (settling time specifications reflect performance with an external feedback resistor but with no external capacitance).

Noise Analysis

Approximate noise figure can be determined for the KH205 using the **Equivalent Input Noise** plot on page 3 and the equations shown below.

- kT = 4.00 x 10⁻²¹ Joules at 290°K
- V_n is spot noise voltage (V/√Hz)
- i_n is non-inverting spot noise current (A/√Hz)
- i_i is inverting spot noise current (A/√Hz)

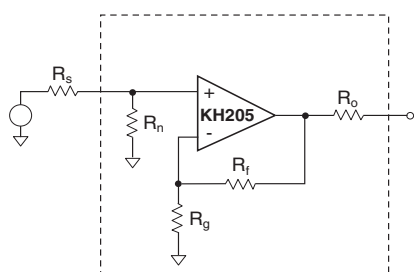

$$F = 10 \log \left[1 + \frac{R_s}{R_n} + \frac{R_s}{4kT} \cdot \left(i_n^2 + \frac{V_n^2}{R_p^2} + \frac{R_f^2 i_i^2}{R_p^2 A_v^2} \right) \right]$$

where $R_p = \frac{R_s R_n}{R_s + R_n}$; $A_v = \frac{R_f}{R_g} + 1$

Figure 5: Noise Figure Diagram and Equations (Noise Figure is for the Network Inside this Box.)

Driving Cables and Capacitive Loads

When driving cables, double termination is used to prevent reflections. For capacitive load applications, a small series resistor at the output of the KH205 will improve stability and settling performance.

Transmission Line Matching

One method for matching the characteristic impedance (Z₀) of a transmission line or cable is to place the appropriate resistor at the input or output of the amplifier. Figure 6 shows typical inverting and non-inverting circuit configurations for matching transmission lines.

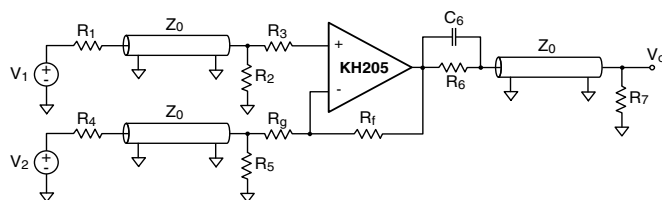

Figure 6: Transmission Line Matching

Non-inverting gain applications:

- Connect R_g directly to ground.
- Make R₁, R₂, R₆, and R₇ equal to Z₀.
- Use R₃ to isolate the amplifier from reactive loading caused by the transmission line, or by parasitics.

Inverting gain applications:

- Connect R₃ directly to ground.
- Make the resistors R₄, R₆, and R₇ equal to Z₀.
- Make R₅ || R_g = Z₀.

The input and output matching resistors attenuate the signal by a factor of 2, therefore additional gain is needed. Use C₆ to match the output transmission line over a greater frequency range. C₆ compensates for the increase of the amplifier's output impedance with frequency.

Dynamic Range (Intermods)

For RF applications, the KH205 specifies a third order intercept of 30dBm at 60MHz and P₀ = 10dBm. A **2-Tone, 3rd Order IMD Intercept** plot is found in the **Typical Performance Characteristics** section. The output power level is taken at the load. Third-order harmonic distortion is calculated with the formula:

$$HD3^{rd} = 2 \cdot (IP3_0 - P_0)$$

where:

- $IP3_o$ = third-order output intercept, dBm at the load.
- P_o = output power level, dBm at the load.
- $HD3^{rd}$ = third-order distortion from the fundamental, -dBc.
- dBm is the power in mW, at the load, expressed in dB.

Realized third-order output distortion is highly dependent upon the external circuit. Some of the common external circuit choices that improve 3rd order distortion are:

- short and equal return paths from the load to the supplies.
- de-coupling capacitors of the correct value.
- higher load resistance.
- a lower ratio of the output swing to the power supply voltage.

Printed Circuit Layout

As with any high frequency device, a good PCB layout will enhance the performance of the KH205. Good ground plane construction and power supply bypassing close to the package are critical to achieving full performance. In the non-inverting configuration, the amplifier is sensitive to stray capacitance to ground at the inverting input. Hence, the inverting node connections should be small with minimal stray capacitance to the ground plane or other nodes. Shunt capacitance across the feedback resistor should not be used to compensate for this effect. General layout and supply bypassing play major roles in

high frequency performance. Follow the steps below as a basis for high frequency layout:

- Include 6.8 μ F tantalum and 0.1 μ F ceramic capacitors on both supplies.
- Place the 6.8 μ F capacitors within 0.75 inches of the power pins.
- Place the 0.1 μ F capacitors less than 0.1 inches from the power pins.
- Remove the ground plane under and around the part, especially near the input and output pins to reduce parasitic capacitance.
- Minimize all trace lengths to reduce series inductances.
- Use flush-mount printed circuit board pins for prototyping, never use high profile DIP sockets.

Evaluation PC boards (part number 730008 for inverting, 730009 for non-inverting) for the KH205 are available to aid in device testing.

KH205 Package Dimensions

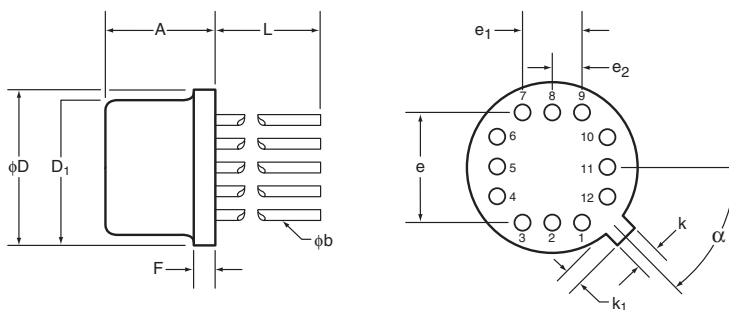

TO-8				
SYMBOL	INCHES		MILIMETERS	
	Minimum	Maximum	Minimum	Maximum
A	0.142	0.181	3.61	4.60
ϕb	0.016	0.019	0.41	0.48
ϕD	0.595	0.605	15.11	15.37
ϕD_1	0.543	0.555	13.79	14.10
e	0.400 BSC		10.16 BSC	
e ₁	0.200 BSC		5.08 BSC	
e ₂	0.100 BSC		2.54 BSC	
F	0.016	0.030	0.41	0.76
k	0.026	0.036	0.66	0.91
k ₁	0.026	0.036	0.66	0.91
L	0.310	0.340	7.87	8.64
α	45° BSC		45° BSC	

NOTES:
 Seal: cap weld
 Lead finish: gold per MIL-M-38510
 Package composition:
 Package: metal
 Lid: Type A per MIL-M-38510

Life Support Policy

Cadeca's products are not authorized for use as critical components in life support devices or systems without the express written approval of the president of Cadeca Microcircuits, Inc. As used herein:

1. Life support devices or systems are devices or systems which, a) are intended for surgical implant into the body, or b) support or sustain life, and whose failure to perform, when properly used in accordance with instructions for use provided in the labeling, can be reasonably expected to result in a significant injury to the user.
2. A critical component is any component of a life support device or system whose failure to perform can be reasonably expected to cause the failure of the life support device or system, or to affect its safety or effectiveness.

Cadeca does not assume any responsibility for use of any circuitry described, and Cadeca reserves the right at any time without notice to change said circuitry and specifications.